

Dedicated to People Flow™

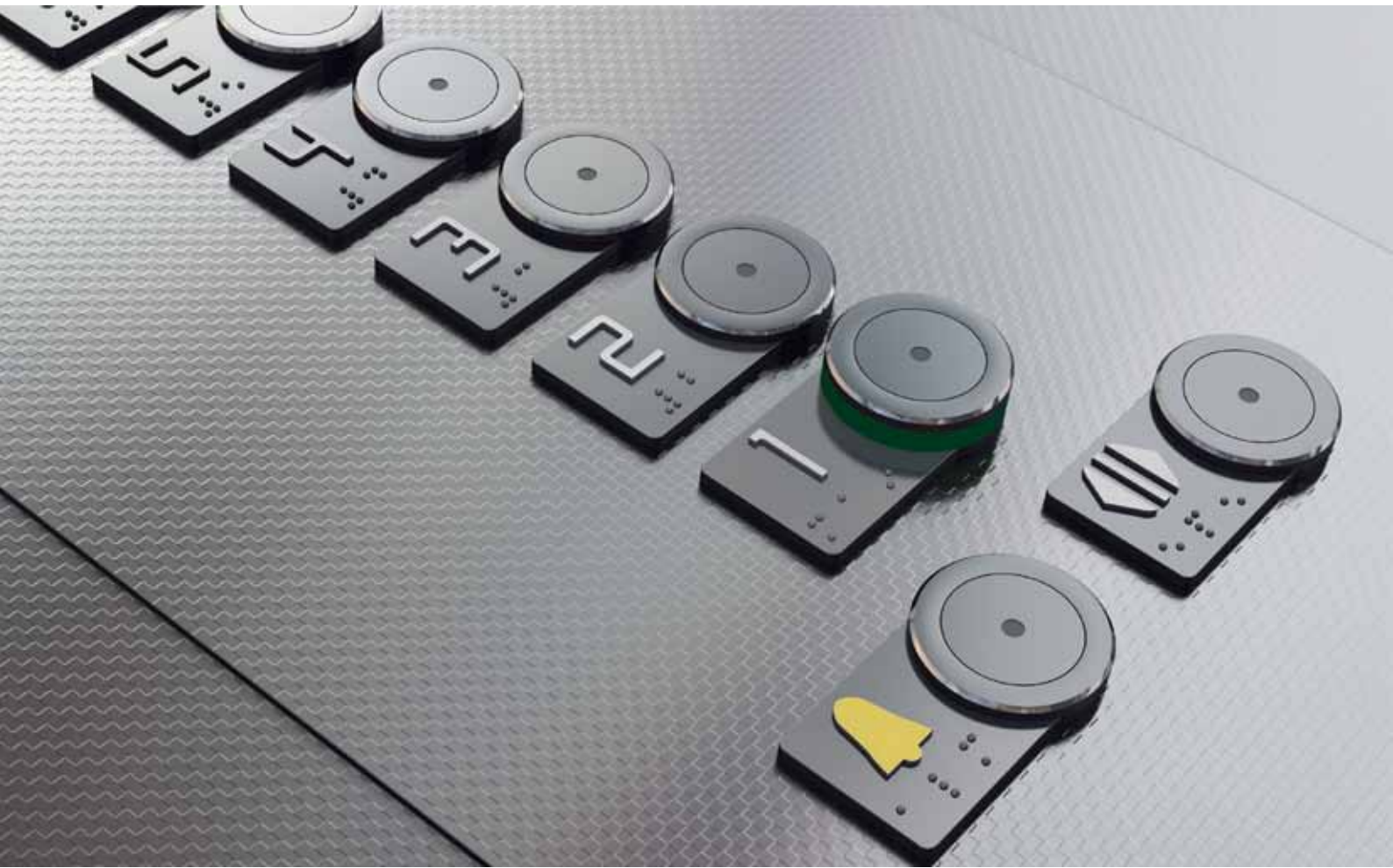

KONE EN81-71 CATEGORY 1

Vandal Resistant Lift

Car Finishing Options: MonoSpace Standard

Ceilings LF94



Doors

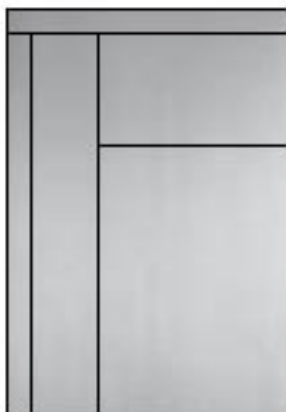

Asturias Satin (F)

Walls

Stainless steel



Asturias Satin (F)



Flemish Linen (M)



Scottish Quad (K)

Floors



Diorite Black (SF2)



Bianco Perla (SF5)

Handrail



HR53, HR53L or HR51TR

Car Finishing Options: MonoSpace Exclusive

Ceilings LF1



Doors

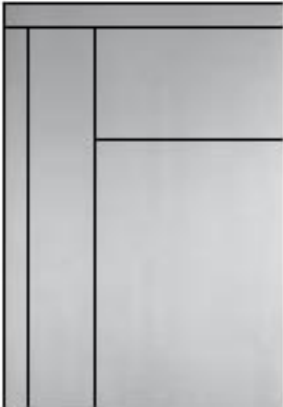

Asturias Satin (F)

Walls

Stainless steel



Asturias Satin (F)



Flemish Linen (M)



Scottish Quad (K)



Tahoe leather (G)



Artic mesh (D)

Floors



Diorite Black (SF2)



Bianca Perla (SF5)

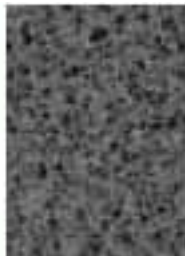

Tuscan Grey (SF6)



Marble White (SF21)



Pacific Blue (SF22)



Ayres Red (SF23)

Handrail



HR41R

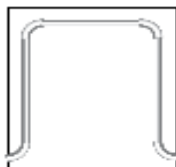

HR41TR

Car operating panel (COP)

- An impact, scratch and burn resistant signalisation
- All devices are splash resistant and easy to clean (IPX3)
- The durable yet attractive design makes it ideal for public transport, airports, public buildings, goods, residential, and office or retail elevators.
- Complies with European standard (EN81-71) for vandal resistant elevators Category 1 requirements
- Complies with European accessibility standard (EN81-70)
- All signalisation is compliant with EN81-72 and EN81-73
- Up to 16 floors; (max. 14 floors for EN81-70 and EN81-72; max. 12 floors)

Faceplate finishing: Scottish Quad, textured stainless steel and Asturias Satin stainless steel

Displays: Scrolling dot matrix

Color: Amber

Buttons: Round, surface mounted steel. Markings on the symbol plate beside the button, optionally braille available (EN81-71, Category 1)

Fixing type: Flush mounted with KONE shield screws.

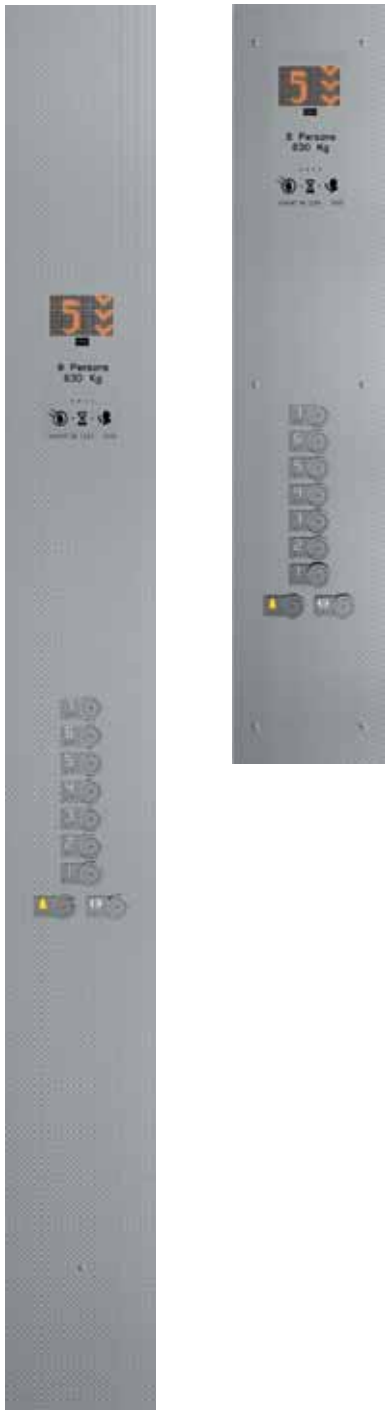

KSC 143

Partial height COP

EN81-70

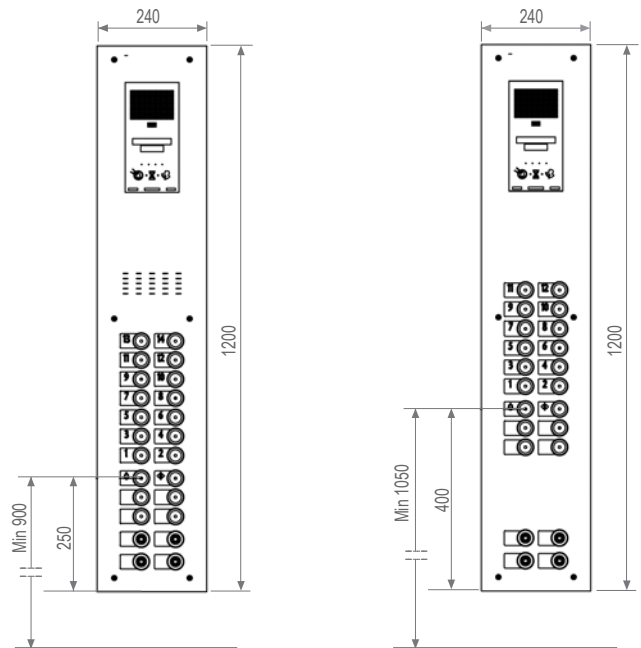

Full height COP

EN81-70

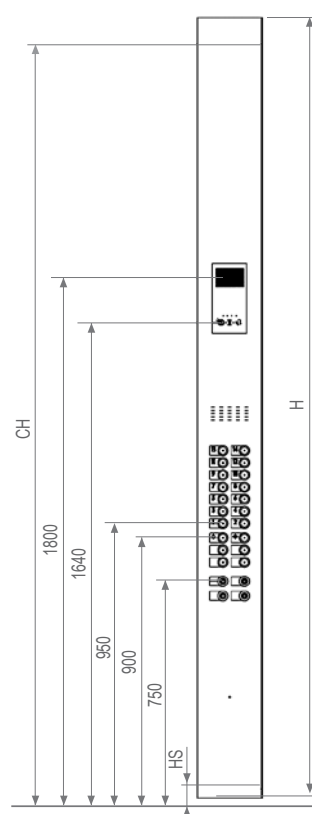

LAW13

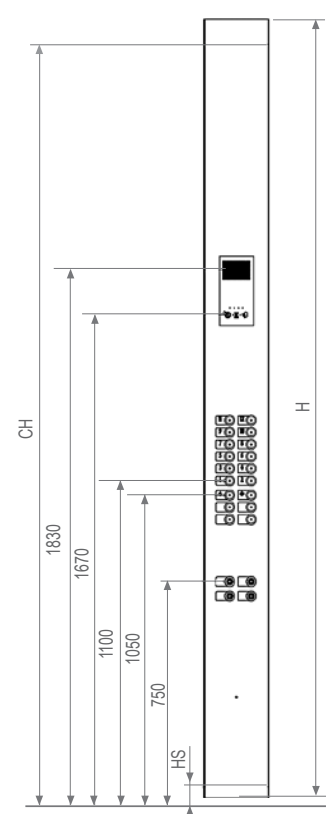

KSS 140 functions and features

Dual function emergency symbols

The integrated emergency symbols have a dual function, working as an emergency light and as a call connection sequence indicator.

Emergency light



In case of a power failure the symbols are backlit with bright light, illuminating the car and ensuring the instructions are clearly visible for persons trapped in the car.

Emergency connection indicators



The amber alarm bell symbol lights up when the alarm button is pressed.



The symbols light up step by step showing the progression of the call.



When the green light is on, the call is connected to the emergency call center.



Durable faceplates

The textured faceplates conceal scratches and keep the devices in good condition for longer. In addition they offer attractive design features for both new and existing elevators.

Shielded display units

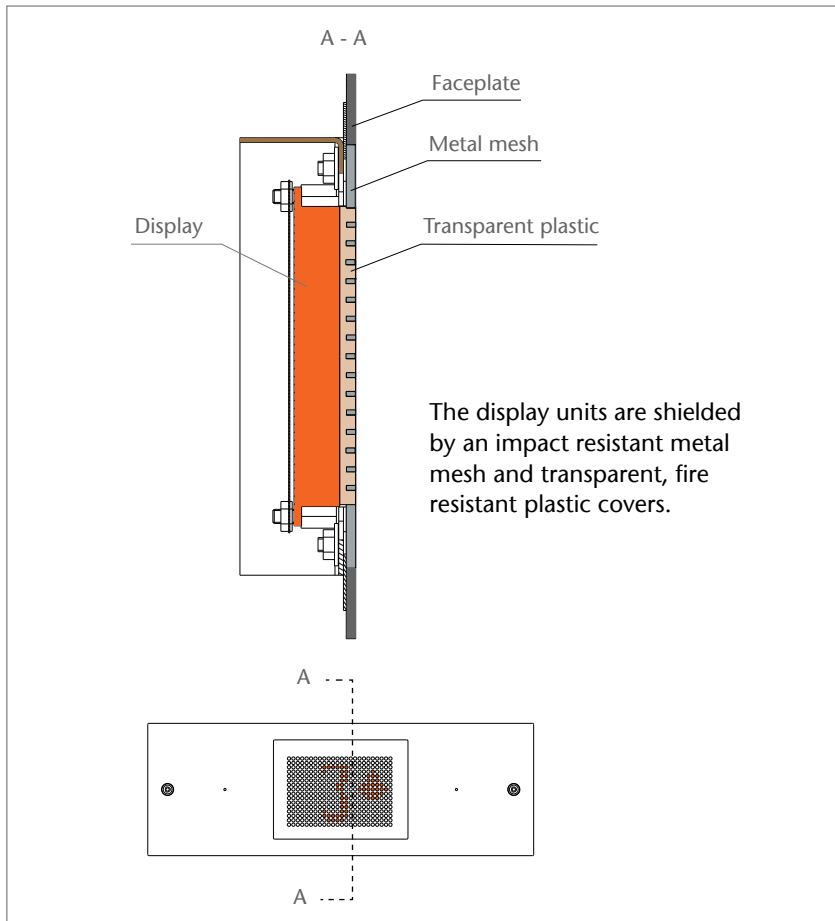

The display units are shielded by an impact resistant metal mesh and transparent, fire resistant plastic covers.

Landing signalisation

Display

- All devices are impact, scratch and burn resistant.
- The displays are covered by a strong steel mesh.
- The cutouts for the display lights are filled with fire resistant transparent plastic.
- Available in variable dimensions to fit existing faceplate spaces.

Hall lantern indicator



KSI 143

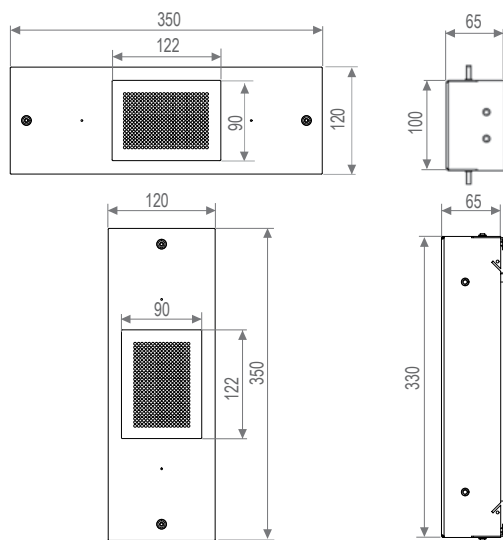

Hall lantern



KSH 140

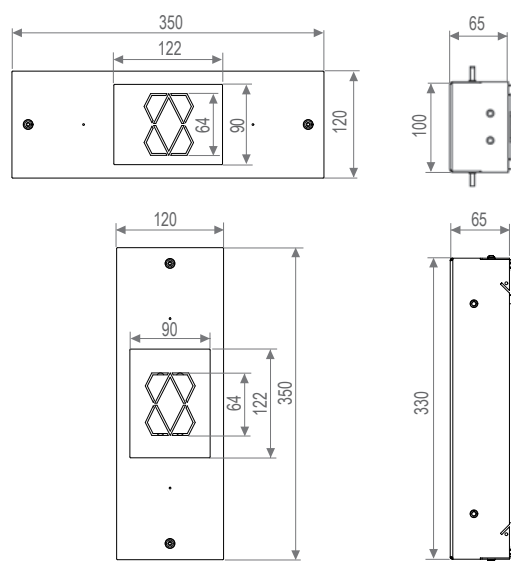

KSH 140

Landing call station



KSL 140

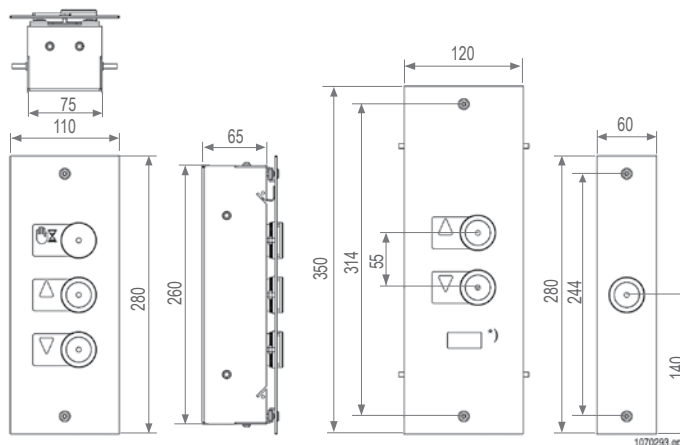

1070293.eps